



LoRaWAN[®] Solenoid Valve Controller

UC51x Series

User Guide



Safety Precautions

Milesight will not shoulder responsibility for any loss or damage resulting from not following the instructions of this operating guide.

- ❖ The device must not be remodeled in any way.
- ❖ Do not place the device close to objects with naked flames.
- ❖ Do not place the device where the temperature is below/above the operating range.
- ❖ Make sure electronic components do not drop out of the enclosure while opening.
- ❖ When installing the battery, please install it accurately, and do not install the reverse or wrong model.
- ❖ The device must never be subjected to shocks or impacts.

Declaration of Conformity

UC51x series is in conformity with the essential requirements and other relevant provisions of the CE, FCC, and RoHS.



Copyright©2011-2023 Milesight. All rights reserved.

All information in this guide is protected by copyright law. Whereby, no organization or individual shall copy or reproduce the whole or part of this user guide by any means without written authorization from Xiamen Milesight IoT Co., Ltd.

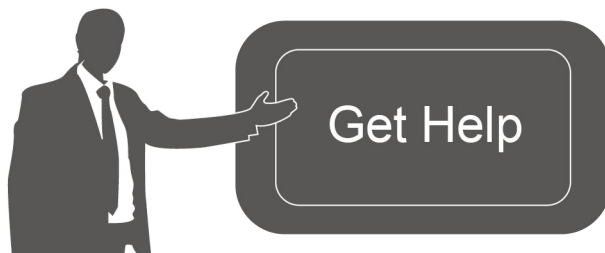

For assistance, please contact

Milesight technical support:

Email: iot.support@milesight.com

Support Portal: support.milesight-iot.com

Tel: 86-592-5085280

Fax: 86-592-5023065

Address: Building C09, Software Park III,
Xiamen 361024, China

Revision History

Date	Doc Version	Description
Feb. 20, 2021	V 1.0	Initial version
Nov.26, 2021	V 1.1	Description Update
March 10, 2021	V 2.0	Update based on hardware 2.x
June 15, 2022	V 2.1	<ol style="list-style-type: none">1. Add internal interface description;2. UC511 supports Class C to B mode;3. GPIO supports selecting DI or pulse mode;4. Update re-join mode and confirmed mode description.
Nov. 21, 2022	V 2.2	Add prevent jitter delay time when GPIO works as DI mode
March 23, 2023	V 3.0	Update based on hardware 3.x

Contents

1. Product Introduction	5
1.1 Overview	5
1.2 Features	5
2. Hardware Introduction	5
2.1 Packing List	5
2.2 Hardware Overview	6
2.3 Internal Interfaces	7
2.4 Dimensions (mm)	8
3. Operation Guide	8
3.1 Log in the ToolBox	8
3.1.1 NFC Configuration	8
3.1.2 USB Configuration	9
3.2 Solenoid Valve Control	10
3.3 LoRaWAN Settings	11
3.3.1 Basic Settings	11
3.3.2 Frequency Settings	12
3.3.3 Multicast Settings	13
3.4 Solenoid Settings	15
3.5 Schedule Settings	17
3.6 Data Storage	19
3.7 Data Retransmission	20
3.8 Maintenance	21
3.8.1 Upgrade	21
3.8.2 Backup	22
3.8.3 Reset to Factory Default	24
4. Installation	25
5. Milesight IoT Cloud Management	26
5.1 Add UC51x to Cloud	26
5.2 Solenoid Valve Control	28
6. Device Payload	30

1. Product Introduction

1.1 Overview

UC51x series LoRaWAN® wireless solenoid valve controller is a device used to remotely control DC latching solenoids of the valve. It contains 2 solenoid interfaces and 2 GPIO interfaces, which can be easily controlled locally or remotely.

Besides ultra-low-power LoRaWAN® technology, UC51x series also provides both solar and built-in battery power supply for uninterrupted operation. For outdoor applications, it equips with IP67-rated enclosure and M12 connectors to protect from water and dust under harsh environments.

1.2 Features

- Compatible with standard DC latching solenoids
- OPEN/CLOSE control by mobile App locally or commands remotely
- Two GPIO interfaces for flow monitoring or valve status monitoring
- Transmission distance up to 15 km with line of sight
- Waterproof design including IP67 case and M12 connectors
- Solar powered and built-in chargeable batteries
- Quick wireless configuration via NFC
- Time and flow control via Milesight IoT Cloud

2. Hardware Introduction

2.1 Packing List



1 × UC51x
Device



2 × Data Cables
(1.5m)

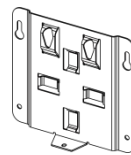

1 × Mounting
Bracket

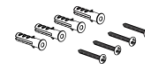

4 × Wall
Mounting Kits



2 × Hose Clamps



1 × Fixing Screw



1 × Quick Guide



1 × Warranty Card



1 × LoRaWAN®
Magnetic Antenna
(EA Version Only)



1 × Power Cable
(30cm)
(UC511 EA Optional)

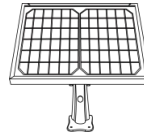

1 × Solar Panel Kit
(UC511 EA
Optional)

! If any of the above items is missing or damaged, please contact your sales Representative.

2.2 Hardware Overview

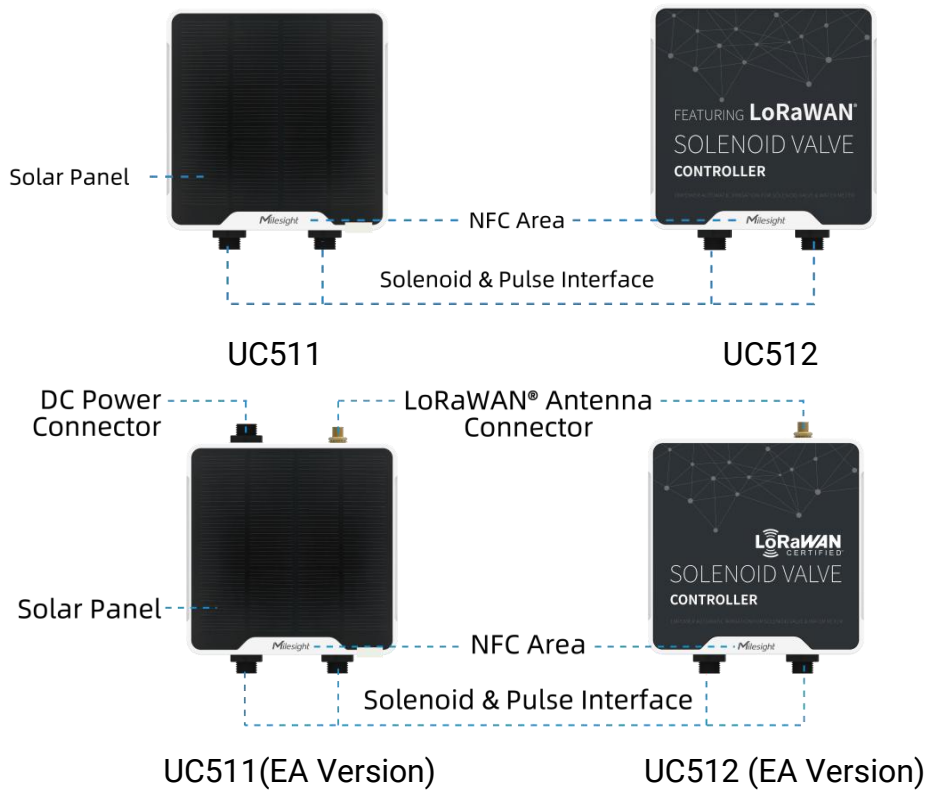

Data Interface 1&2:

Pin	Description
1	DC+/OUT1 of Solenoid Valve
2	DC-/OUT2 of Solenoid Valve
3	GND
4	INSERT BOOT ¹

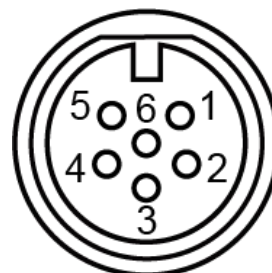

¹ PIN3 and PIN4 do not need to connect, see "Solenoid Valve Switch" option in [section 3.4](#).

5	GND
6	GPIO Interface

Power Interface (UC511-EA):

Pin	Description
1	VCC(5-24V)
2	GND

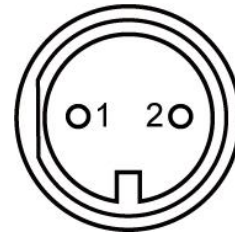

2.3 Internal Interfaces

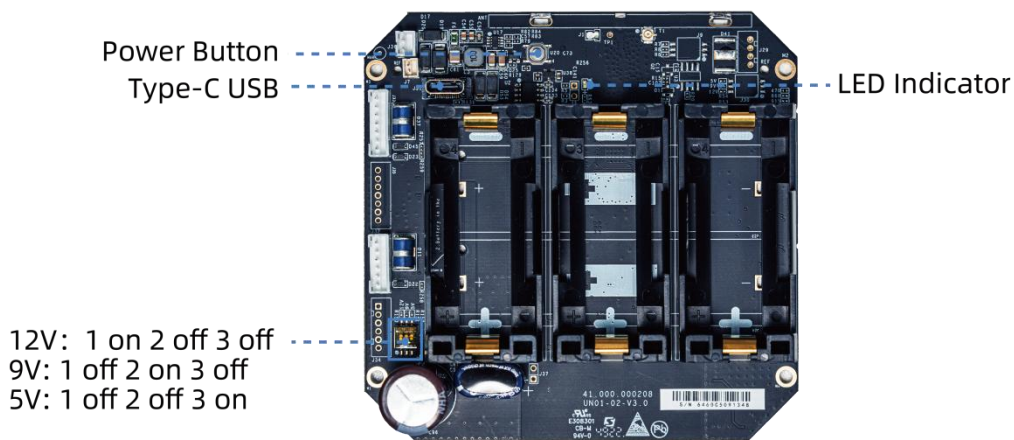

DIP Switch:

Interface	DIP Switch
Solenoid Interface	12V: 1 on 2 off 3 off
	9V: 1 off 2 on 3 off
	5V: 1 off 2 off 3 on

Note:

- 1) The DIP switch is set to 12VDC by default.
- 2) The DIP switch does not support setting two solenoid interfaces as different voltage types.

Power Button:

Function	Action	LED Indication
Turn On	Press and hold the button for more than 3s.	Off → On
Turn Off	Press and hold the button for more than 3s.	On → Off
Reset	Press and hold the button for more than 10s.	Blinks.
Check On/Off Status	Quickly press the power button.	Light On: Device is on.
		Light Off: Device is off.

2.4 Dimensions (mm)

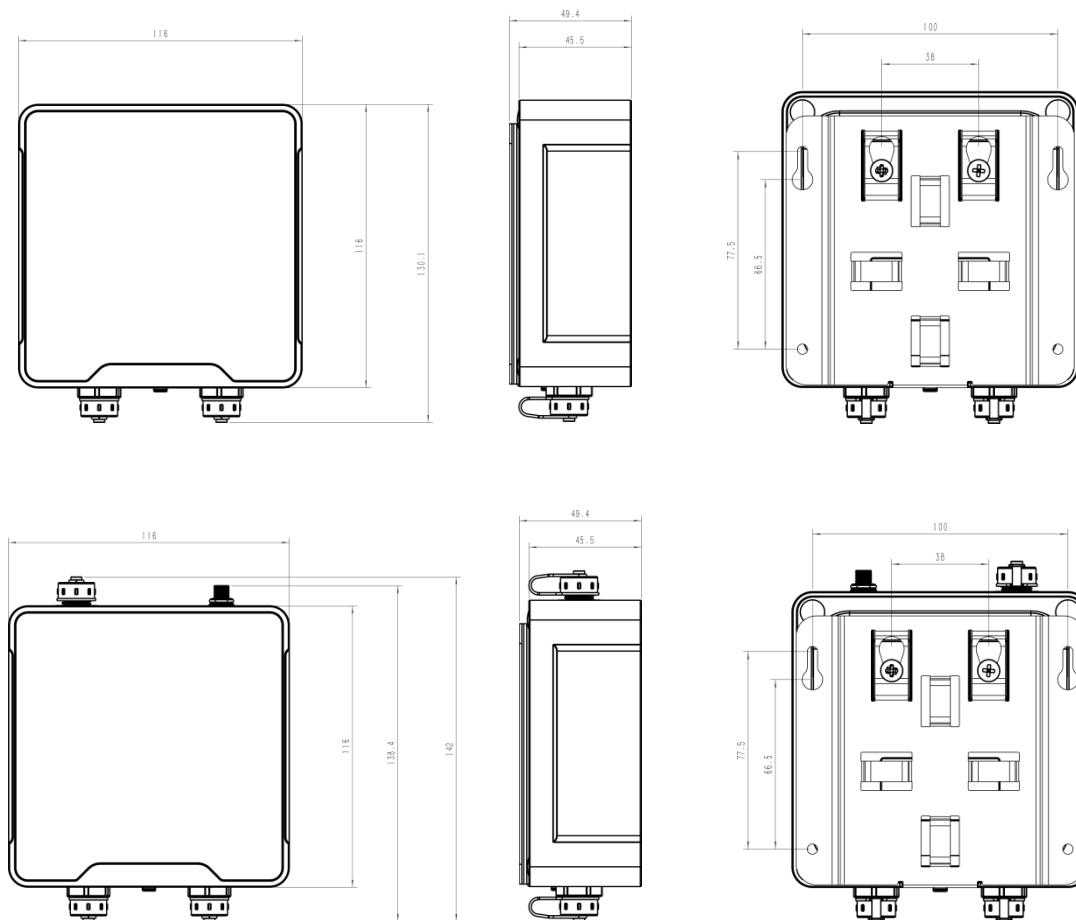

3. Operation Guide

3.1 Log in the ToolBox

UC51x series can be monitored and configured via ToolBox App or ToolBox software. Please select one of them to complete configuration.

3.1.1 NFC Configuration

1. Download and install "Milesight ToolBox" App from Google Play or Apple App Store.
2. Enable NFC on the smartphone and launch Milesight ToolBox.
3. Attach the smartphone with NFC area to the device to read basic information.
4. Basic information and settings of devices will be shown on ToolBox if it's recognized successfully. You can read and configure the device by tapping the button on the Device Status. In order to protect the security of devices, password validation is required when first configuration. Default password is **123456**.

**Note:**

- 1) Ensure the location of smartphone NFC area and it's recommended to take off phone case.
- 2) If the smartphone fails to read/write configurations via NFC, keep the phone away and back to try again.
- 3) UC51x series can also be configured by dedicated NFC reader, which can be purchased from Milesight IoT.

3.1.2 USB Configuration

1. Download ToolBox from [Milesight IoT website](#).
2. Open the case of UC51x and connect the UC51x to computer via type-C port.

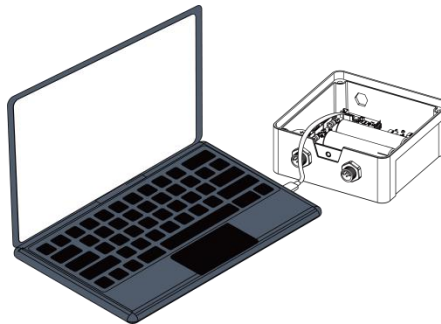

3. Open the ToolBox and select type as "General", then click password to log in ToolBox. (Default password: **123456**)

Setting	Value
Type	General
Serial port	COM4
Login password	
Baud rate	115200
Data bits	8
Parity bits	None
Stop bits	1

4. After logging in the ToolBox, you can click "Power On" or "Power Off" to turn on/off device and change other settings.

Status > Power On

Model:	UC512-DI-868M
Serial Number:	646
Device EUI:	24e1244
Firmware Version:	02.02
Hardware Version:	2.1
Device Status:	Off
Join Status:	-
RSSI/SNR:	-
Valve1 Status:	
Counter1:	12
Valve2 Status:	
Counter2:	33
Battery:	-
Channel Mask:	-
Uplink Frame-counter:	-
Downlink Frame-counter:	-

3.2 Solenoid Valve Control

Solenoid valve can be controlled by ToolBox App or ToolBox software locally.

Via ToolBox Software:

Click **Open** or **Close** button on the **Status** page to change the status of solenoid valves.

Status >

Model:	UC512-DI-868M
Serial Number:	6460
Device EUI:	24e1244
Firmware Version:	02.02
Hardware Version:	2.1
Device Status:	On
Join Status:	Activate
RSSI/SNR:	-31/10
Valve1 Status:	Open Close
Counter1:	1 Clear
Valve2 Status:	Close Open
Counter2:	17 Clear
Battery:	100%
Channel Mask:	00ff

Via ToolBox App:

Click buttons of Valve Status on the **Device > Status** page, then attach the smart phone to device to change the status of solenoid valves.

Status	Setting	Maintenance
Device Status	ON	<input checked="" type="checkbox"/>
Join Status	Activated	
RSSI/SNR	-48/10	
Device Time	2022-01-27 09:05	<input type="button" value="Sync"/>
Valve 1 Status	Off	<input type="checkbox"/>
Valve 2 Status	Off	<input type="checkbox"/>
Counter 1	474	<input type="button" value="Clear"/>
Counter 2	438	<input type="button" value="Clear"/>
Battery	100 %	

3.3 LoRaWAN Settings

LoRaWAN settings is used for configuring the transmission parameters in LoRaWAN® network.

3.3.1 Basic Settings

UC51x supports basic configurations like join type, App EUI, App Key and other information. You can also keep all settings by default.

Device EUI	<input type="text" value="24E124"/>
App EUI	<input type="text" value="24E124C0002A0001"/>
Application Port	<input type="text" value="85"/>
Join Type	<input type="text" value="OTAA"/>
LoRaWAN Version	<input type="text" value="V1.1.0"/>
Application Key	<input type="text" value="*****"/>
RX2 Data Rate	<input type="text" value="DR0 (SF12, 125k)"/>
RX2 Frequency	<input type="text" value="869525000"/>
Spread Factor	<input type="text" value="SF10-DR2"/>
Confirmed Mode	<input type="checkbox"/>
Rejoin Mode	<input checked="" type="checkbox"/>
Set the number of packets sent	<input type="text" value="32"/> packets
ADR Mode	<input checked="" type="checkbox"/>
TXPower	<input type="text" value="TXPower0-16 dBm"/>

Parameters	Description
------------	-------------

Device EUI	Unique ID of the device which can also be found on the label.
App EUI	Default App EUI is 24E124C0002A0001.
Application Port	The port used for sending and receiving data, default port is 85.
Join Type	OTAA and ABP mode are available.
LoRaWAN Version	V1.0.2 and V1.0.3 are available.
Application Key	Appkey for OTAA mode, default is 5572404C696E6B4C6F52613230313823.
Device Address	DevAddr for ABP mode, default is the 5 th to 12 th digits of SN.
Network Session Key	Nwkskey for ABP mode, default is 5572404C696E6B4C6F52613230313823.
Application Session Key	Appskey for ABP mode, default is 5572404C696E6B4C6F52613230313823.
RX2 Data Rate	RX2 data rate to receive downlinks.
RX2 Frequency	RX2 frequency to receive downlinks. Unit: Hz
Spread Factor	If ADR is disabled, the device will send data via this spread factor.
Confirmed Mode	If the device does not receive ACK packet from network server, it will resend data once.
Rejoin Mode	The device will send a specific number of LinkCheckReq MAC packets to the network server every 30 mins to validate connectivity; If there is no response, the device will re-join the network.
Set the number of packets sent	When rejoin mode is enabled, set the number of LinkCheckReq packets sent.
ADR Mode	Allow network server to adjust datarate of the device.
Tx Power	Tx power of the device.

Note:

- 1) Please contact sales for device EUI list if there are many units.
- 2) Please contact sales if you need random App keys before purchase.
- 3) Select OTAA mode if you use Milesight IoT cloud to manage devices.
- 4) Only OTAA mode supports rejoin mode.

3.3.2 Frequency Settings

Select supported frequency and channels to send uplinks. Make sure the channels match the LoRaWAN® gateway.

Basic
Channel

Support Frequency : EU868

<input type="checkbox"/>	Index	Frequency/MHz	Max Datarate	Min Datarate
<input checked="" type="checkbox"/>	0	<input style="width: 80px;" type="text" value="868.1"/>	5-SF7BW125	0-SF12BW125
<input checked="" type="checkbox"/>	1	<input style="width: 80px;" type="text" value="868.3"/>	5-SF7BW125	0-SF12BW125
<input checked="" type="checkbox"/>	2	<input style="width: 80px;" type="text" value="868.5"/>	5-SF7BW125	0-SF12BW125
<input type="checkbox"/>	3	<input style="width: 80px;" type="text" value="0"/>	5-SF7BW125	0-SF12BW125
<input type="checkbox"/>	4	<input style="width: 80px;" type="text" value="0"/>	5-SF7BW125	0-SF12BW125
<input type="checkbox"/>	5	<input style="width: 80px;" type="text" value="0"/>	5-SF7BW125	0-SF12BW125
<input type="checkbox"/>	6	<input style="width: 80px;" type="text" value="0"/>	5-SF7BW125	0-SF12BW125
<input type="checkbox"/>	7	<input style="width: 80px;" type="text" value="0"/>	5-SF7BW125	0-SF12BW125

If frequency is one of CN470/AU915/US915, you can enter the index of the channel that you want to enable in the input box, making them separated by commas.

Examples:

1, 40: Enabling Channel 1 and Channel 40

1-40: Enabling Channel 1 to Channel 40

1-40, 60: Enabling Channel 1 to Channel 40 and Channel 60

All: Enabling all channels

Null: Indicates that all channels are disabled

Support Frequency : AU915

Enabled Channel Index: 0-71

Channel Index	Frequency/MHz	Channel Spacing/MHz	BW/kHz
0 - 15	915.2 - 918.2	0.2	125
16 - 31	918.4 - 921.4	0.2	125
32 - 47	921.6 - 924.6	0.2	125
48 - 63	924.8 - 927.8	0.2	125
64 - 71	915.9 - 927.1	1.6	500

3.3.3 Multicast Settings

UC51x supports setting up several multicast groups to receive multicast commands from network servers and users can use this feature to control devices in bulks.

1. Enable Multicast Group and set a unique multicast address and keys to distinguish other groups. You can also keep these settings by default.

Multicast Group 1	<input checked="" type="checkbox"/>
Multicast Address	<input type="text" value="11111111"/>
Multicast McAppSKey	<input type="text" value="*****"/>
Multicast McNetSKey	<input type="text" value="*****"/>
Multicast Group 2	<input type="checkbox"/>
Multicast Group 3	<input type="checkbox"/>
Multicast Group 4	<input type="checkbox"/>

Parameters	Description
Multicast Address	Unique 8-digit address to distinguish different multicast groups.
Multicast McAppSKey	32-digit key. Default values: Multicast Group 1: 5572404C696E6B4C6F52613230313823 Multicast Group 2: 5572404C696E6B4C6F52613230313824 Multicast Group 3: 5572404C696E6B4C6F52613230313825 Multicast Group 4: 5572404C696E6B4C6F52613230313826
Multicast McNetSKey	32-digit key. Default values: Multicast Group 1: 5572404C696E6B4C6F52613230313823 Multicast Group 2: 5572404C696E6B4C6F52613230313824 Multicast Group 3: 5572404C696E6B4C6F52613230313825 Multicast Group 4: 5572404C696E6B4C6F52613230313826

2. Add a multicast group on the network server. Take Milesight UG6x gateway as an example, go to **Network Server > Multicast Groups**, and click **Add** to add a multicast group.

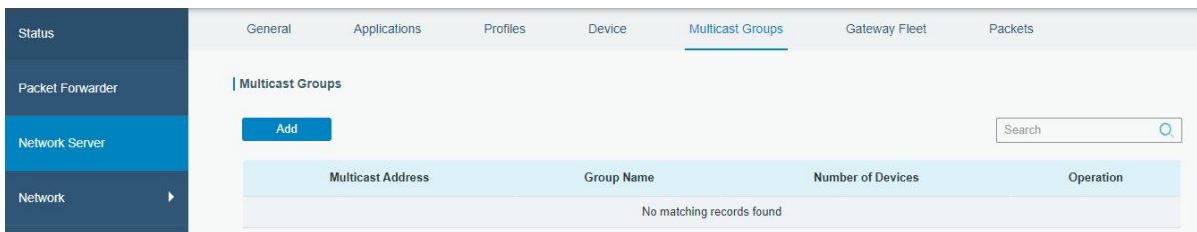

Fill in the multicast group information that is the same as device settings, and select the devices that you need to control, then click **Save**.

Group Name	Valve Control
Multicast Address	11111111
Multicast Network Session Key	5572404C696E6B4C6F526132
Multicast Application Session Key	5572404C696E6B4C6F526132
Class Type	Class C ▼
Datarate	DR0 (SF12, 125 kHz) ▼
Frequency	505300000 Hz
Frame-counter	0
Selected Devices	
UC51X ×	

Multicast Address	Group Name	Number of Devices	Operation
11111111	Valve Control	1	✎ ✕

3. Go to **Network Server > Packets**, select the multicast group and fill in the downlink command, then click **Send**. The network server will broadcast the command to devices that belong to this multicast group.

Note: ensure all devices' application ports are the same.

Device EUI	Type	Payload	Port	Confirmed	Send
0000000000000000	ASCII ▼		85	<input type="checkbox"/>	Send

Multicast Group	Type	Payload	Port	Send
Valve Control ▼	hex ▼	ff1d2100	85	Send

3.4 Solenoid Settings

Go to **Device Settings > Basic** of ToolBox software or **Setting > General Settings** of ToolBox App to change the reporting configurations.

Reporting Interval	<input type="text" value="20"/>	min
Data Storage	<input checked="" type="checkbox"/>	
Data Retransmission	<input type="checkbox"/>	
Solenoid Valve Wiring Switch	<input checked="" type="checkbox"/>	
GPIO1 Acquisition Type	<input type="text" value="Pulse Counter"/>	
GPIO2 Acquisition Type	<input type="text" value="Digital input"/>	
Prevents jitter delay time	<input type="text" value="40"/>	S
Data Reporting	<input type="text" value="All"/>	
Device Return to Power Supply State	<input type="text" value="Return to previous working state"/>	
Class Type	<input type="text" value="Class C"/>	
Change Password	<input type="checkbox"/>	

Parameters	Description
Reporting Interval	Reporting interval of transmitting data to the network server. Default: 20min, Range: 1-1080 mins.
Data Storage	Disable or enable data storage locally. (see section 3.6 to export data)
Data Retransmission	Disable or enable data retransmission. (see section 3.7)
Solenoid Valve Wiring Switch	After this parameter is enabled, when users connect the solenoid cable to any solenoid interface, the device will turn on automatically.
GPIO1/2 Acquisition Type	Select Digital Input or Pulse Counter. Digital input: detect the real state of the valve to know if valve control takes effect. Pulse counter: connect the water meter to measure the flow.
Prevent Jitter Delay Time	The device will not upload GPIO status during this time to avoid frequent uplinks. This only works when GPIO mode is DI and also applies to both GPIO interfaces.
Data Reporting	Select the contents to report to the network server. All: Report all interface status; Valve 1 & Water Meter 1: Report the status of the Valve 1 interface and data of GPIO1; Valve 2 & Water Meter 2: Report the status of the Valve 2 interface and data of GPIO2.

Device Return to Power Supply State	If the device loses power and returns to power supply, the device will be on or off according to this parameter.
Class Type	<p>Working mode of LoRaWAN[®] device.</p> <p>UC511: Class A, Class B, Class C and Class C to B are available;</p> <p>UC512: Class A and Class B are available.</p> <p>Note: for Class B mode, if the device does not receive beacons for more than 30 minutes, it will switch to Class A mode automatically; for Class C to B mode, if the device does not receive beacons for more than 30 minutes, it will switch to Class C mode automatically.</p>
Response Time	<p>When the device works under Class A mode, it only receives control commands at every reporting interval. In order to shorten the delay time of control, the device will send a blank package to allow to receive the control commands at every Response Time interval.</p> <p>Note: The shorter the response time, the shorter the battery life.</p>
Ping Slot Periodicity	When the device works under Class B or Class C to B mode, set the interval to open the reception window.
Change Password	Change the password for ToolBox App or software to read/write this device.

Note:

- 1) When the device connects to the network server of Milesight gateway, the blank package will take up the frame count but not show on the package list.
- 2) Reboot or re-join will not affect the counting.

3.5 Schedule Settings

Go to **Device Settings > Schedule** of ToolBox software or **Setting > Schedule** of ToolBox App to configure the solenoid switch plans.

1. Configure a plan as your request and enable it.

Item	Status	Initial state of solenoid valve	Start Time	End Time	Water Volume(Pulses)	Repeat	Valve
1	<input checked="" type="checkbox"/>	open	7:15	7:18	5	Every Saturday	1&2
2	<input type="checkbox"/>	Closure	0:0	0:0			
3	<input type="checkbox"/>	Closure	0:0	0:0			
4	<input type="checkbox"/>	Closure	0:0	0:0			
5	<input type="checkbox"/>	Closure	0:0	0:0			
6	<input type="checkbox"/>	Closure	0:0	0:0			
7	<input type="checkbox"/>	Closure	0:0	0:0			
8	<input type="checkbox"/>	Closure	0:0	0:0			
9	<input type="checkbox"/>	Closure	0:0	0:0			
10	<input type="checkbox"/>	Closure	0:0	0:0			
11	<input type="checkbox"/>	Closure	0:0	0:0			
12	<input type="checkbox"/>	Closure	0:0	0:0			
13	<input type="checkbox"/>	Closure	0:0	0:0			
14	<input type="checkbox"/>	Closure	0:0	0:0			
15	<input type="checkbox"/>	Closure	0:0	0:0			
16	<input type="checkbox"/>	Closure	0:0	0:0			

Condition	Description
Item	It supports adding 16 plans at most.
Status	Enable or disable this plan.
Initial State of Solenoid Valve	Control the solenoid to open or close the valve during the plan.
Start Time/End Time	Set the time range to execute this plan.
Water Volume (Pulses)	Set the amount of water flow through the valve during this plan, 0 means this condition will not work. Note: 1) Either time or water volume reaches the condition, the plan is completed and will stop executing. 2) When the GPIO type is not pulse counter, this condition will not work.
Repeat	Set the regularly weekly schedule to execute this plan. If none is selected, the plan will only execute once.

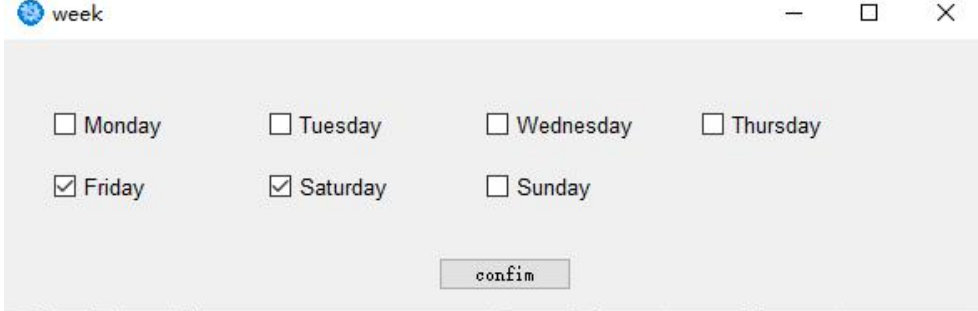
	 <p>The screenshot shows a dialog box titled 'week' with a gear icon. It contains seven checkboxes for the days of the week: Monday, Tuesday, Wednesday, Thursday, Friday, Saturday, and Sunday. The checkboxes for Friday and Saturday are checked. A 'confirm' button is located at the bottom center of the dialog box.</p>
Valve	Select the valve you need to control.

2. Click **Write** to write the schedule plan setting into the device.
3. Click **Save Schedule** to backup the schedule plan settings as a file; if you need to import this schedule from other devices, click **Read Schedule** to import the setting.
4. Click **Clear All** to reset all schedule plan settings in this device.

Note:

- 1) Ensure the device time is correct. After joining the network, the network server will assign the time to the device. You can also manually sync the time via ToolBox or downlink commands.
- 2) When the device has multiple schedule plan settings that are conflicted, the device will only execute one plan whose item number is the largest.

3.6 Data Storage

UC51x series supports storing 1000 data records locally and exports data via ToolBox App or ToolBox software. The device will record the data according to the reporting interval even if it is not connected to a network.

1. Go to **Status** of ToolBox software or **Device > Status** of ToolBox App to sync the device time;
2. Go to **Device Settings > Basic** of ToolBox software or **Device > Settings > General Settings** of ToolBox App to enable data storage feature.
3. Go to **Maintenance > Basic** of ToolBox software or **Device > Maintenance** of ToolBox App, click **Export**, then select the data time range and click **Save** to export data.

Note: ToolBox App can only export the last 14 days' data. If you need to export more data, please use ToolBox software.

4. Click **Clear** to clear all stored data inside the device.

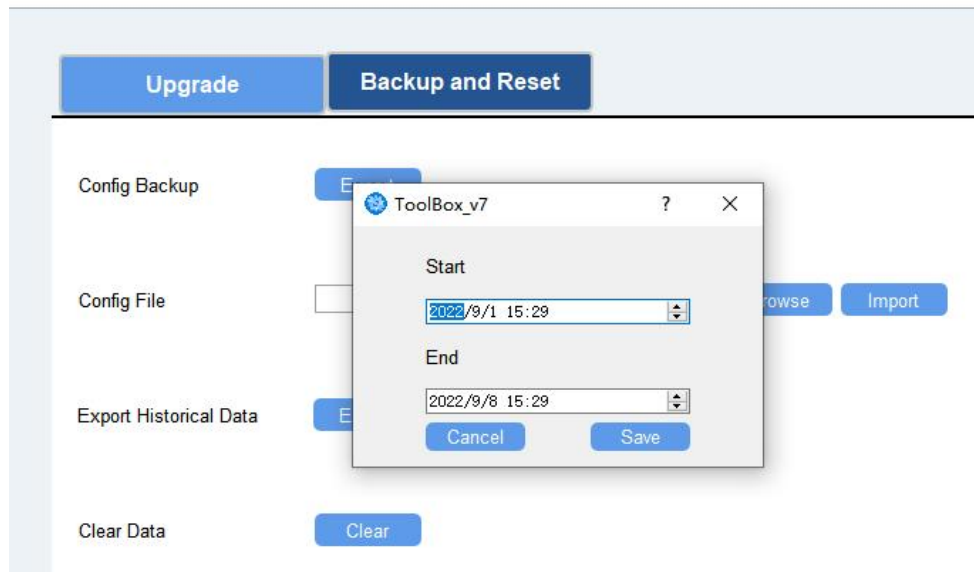
Maintenance >**3.7 Data Retransmission**

UC51x series supports data retransmission to ensure the network server can get all data even if the network is down for some times. There are two ways to get the lost data:

- Network server sends downlink commands to enquire the historical data for specified time range, see ***UC51x Series Communication Protocol***;
- When network is down if no response from LinkCheckReq MAC packets for a period of time, the device will record the network disconnected time and re-transmit the lost data after the device re-connects the network.

Here are the steps for data retransmission:

1. Use Toolbox software or ToolBox App to sync the time. If you set LoRaWAN® version as 1.0.3, the device will send a request to enquire time from the network server.
2. Enable data storage feature and data retransmission feature;

Settings >

3. Enable rejoin mode feature and set the number of packets sent. Take below as an example, the device will send LinkCheckReq MAC packets to the network server at least every 30 mins to check if the network is disconnected; if there is no response for 8 times (8 * 30 mins = 240 mins = 4 hours), the device will record a data lost time point(disconnection time minus 4 hours).

LoRaWAN >

Basic Channel

Device EUI	<input type="text" value="24E124707C300073"/>
App EUI	<input type="text" value="24E124C0002A0001"/>
Application Port	<input type="text" value="85"/>
Join Type	<input type="text" value="OTAA"/>
LoRaWAN Version	<input type="text" value="V1.0.3"/>
Application Key	<input type="text" value="*****"/>
Spread Factor	<input type="text" value="SF7-DR5"/>
Confirmed Mode	<input type="checkbox"/>
Rejoin Mode	<input checked="" type="checkbox"/>
Set the number of packets sent	<input type="text" value="8"/> packets
ADR Mode	<input checked="" type="checkbox"/>

4. After the network connected back, the device will send the missing data, starting from the point in time when the data was lost, according to the reporting interval.

Note:

- 1) If the device is rebooted or powered off during data retransmission and the process is not completed, the device will resend all retransmitted data again after reconnecting to the network;
- 2) If the network is disconnected again during data retransmission, it will only send the latest disconnection data;
- 3) The retransmission data format is started with "20ce", please refer to ***UC51x Series Communication Protocol***.
- 4) Data retransmission will increase the uplinks and shorten the battery life.

3.8 Maintenance

3.8.1 Upgrade

ToolBox Software:

1. Download firmware from www.milesight-iot.com to your PC.
2. Go to **Maintenance > Upgrade** of ToolBox software, click **Browse** to import firmware and upgrade the device.

Maintenance >

The screenshot shows the 'Maintenance >' section of the ToolBox software. It features two tabs: 'Upgrade' (selected) and 'Backup and Reset'. Below the tabs, the following information is displayed:

- Model: UC512-DI-868M
- Firmware Version: 02.02
- Hardware Version: 2.1
- Domain: Beijing Server (dropdown menu)
- FOTA: Up to date (button)
- Update Locally: [input field] [Browse] [Upgrade]

ToolBox App:

1. Download firmware from www.milesight-iot.com to your smartphone.
2. Open ToolBox App and click **Browse** to import firmware and upgrade the device.

Note:

- 1) Operation on ToolBox is not supported during the upgrade.
- 2) Only Android version ToolBox supports the upgrade feature.

The screenshot shows the 'Maintenance' screen of the ToolBox App for device UC512-DI-868M. The screen has a blue header with a menu icon and the device name. Below the header are three tabs: 'Status', 'Setting', and 'Maintenance' (selected). The main content area displays the following information:

- SN: 6415A51585070020
- Model: UC512-DI-868M
- Firmware Version: V1.12
- Hardware Version: V1.0
- Manual Upgrade: [Browse]

3.8.2 Backup

UC51x devices support configuration backup for easy and quick device configuration in bulk.

Backup is allowed only for devices with the same model and LoRaWAN® frequency band. Note that the backup file will not save schedule setting, please backup plan setting on **Schedule** page. Please select one of following methods to backup device:

ToolBox Software:

1. Go to **Maintenance > Backup and Reset**, click **Export** to save current configuration as json format backup file.
2. Click **Browse** to select backup file, then click **Import** to import the configurations.

The screenshot shows a web interface with a navigation bar at the top containing two tabs: 'Upgrade' and 'Backup and Reset'. The 'Backup and Reset' tab is active. Below the navigation bar, there are three rows of controls:

- The first row is labeled 'Config Backup' and has a blue button labeled 'Export' to its right.
- The second row is labeled 'Config File' and has a text input field, a blue button labeled 'Browse' to its right, and another blue button labeled 'Import' to the right of the 'Browse' button.
- The third row is labeled 'Restore Factory Defaults' and has a blue button labeled 'Reset' to its right.

ToolBox App:

1. Go to **Template** page on the App and save current settings as a template. You can also edit the template file.
2. Select this template and attach to another device to write configuration.

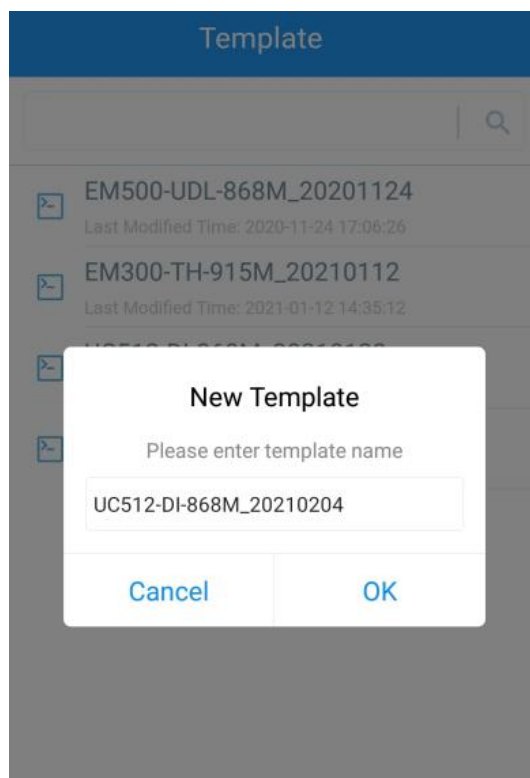

3.8.3 Reset to Factory Default

Please select one of following methods to reset device:

Via Hardware: Open the case of UC51x and hold on power button more than 10s.

Via ToolBox Software: Go to **Maintenance > Backup and Reset** to click **Reset**.

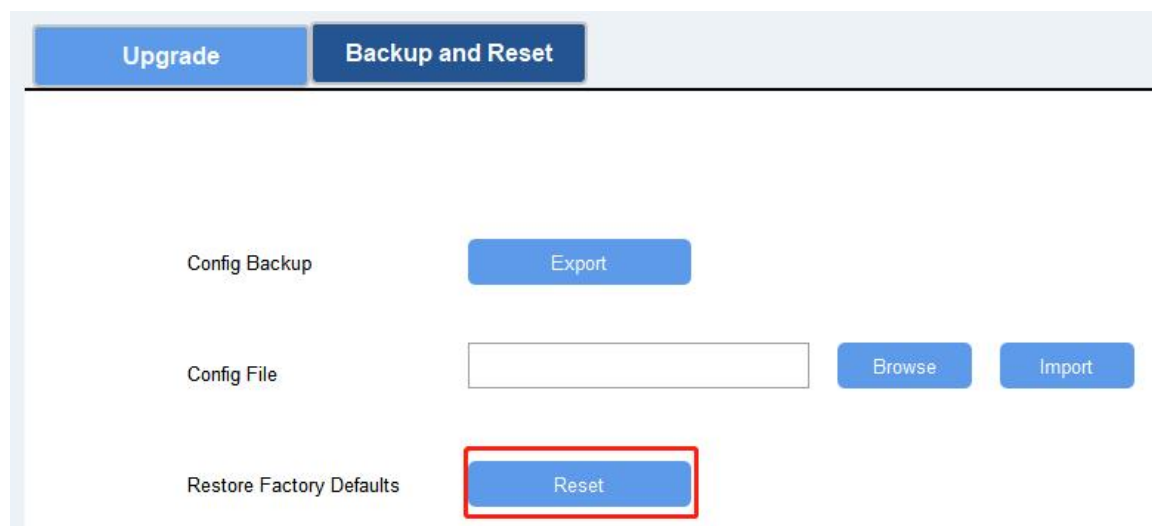

Via ToolBox App: Go to **Device > Maintenance** to click **Reset**, then attach smart phone with NFC area to UC51x to complete reset.

☰UC512-DI-868M

StatusSettingMaintenance

SN	6415A51585070020
Model	UC512-DI-868M
Firmware Version	V1.12
Hardware Version	V1.0
Manual Upgrade	

Browse

Restore Factory Default

Reset

4. Installation

UC51x series support wall mounting or pole mounting. Before installation, make sure you have the mounting bracket, wall or pole mounting kits and other required tools.

Wall Mounting:

1. Fix the wall plugs into the wall, then fix the mounting bracket to the wall plugs with screws.
2. Put the device on the mounting bracket, then fix the bottom of the device to the bracket with a fixing screw. It's necessary to fix this bracket to device, or it will affect the signal.

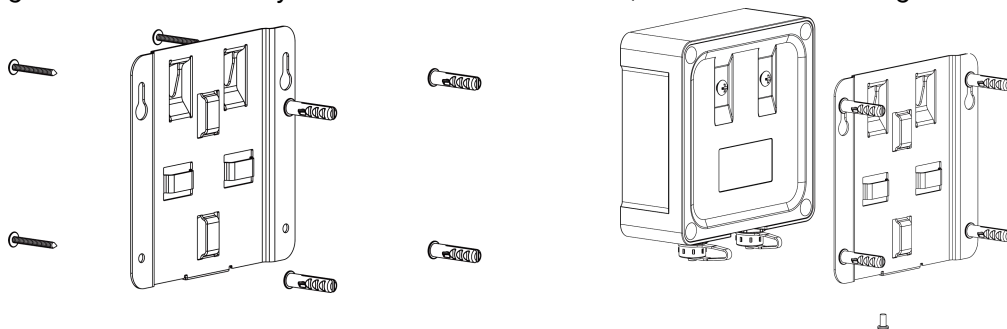

Pole Mounting:

1. Straighten out the hose clamp and slide it through the rectangular rings in the mounting bracket, wrap the hose clamp around the pole. After that use a screwdriver to tighten the locking mechanism by turning it clockwise.

- Put the device on the mounting bracket, then fix the bottom of the device to the bracket with a fixing screw. It's necessary to fix this bracket to device, or it will affect the signal.

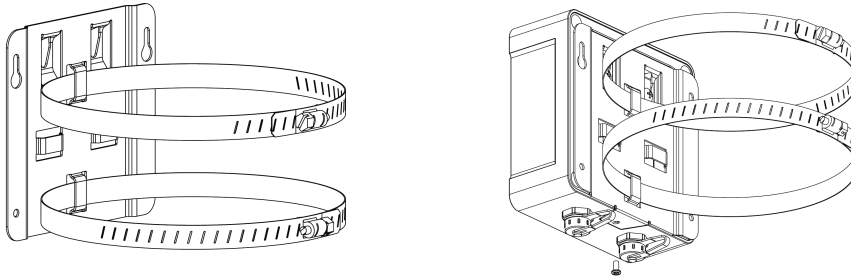

5. Milesight IoT Cloud Management

UC51x series can be managed by Milesight IoT Cloud platform. Milesight IoT cloud is a comprehensive platform that provides multiple services including device remote management and data visualization with the easiest operation procedures. Please register a Milesight IoT Cloud account before operating following steps.

5.1 Add UC51x to Cloud

- Ensure Milesight LoRaWAN[®] gateway is online in Milesight IoT Cloud. For more info about connecting gateway to cloud please refer to gateway's user guide.

Status	Name	Associated Devices (Joined / Not Joined / Failed)	Last Updated
Normal	UG Gateway 621793129987	0 / 0 / 0 Detail	a few seconds ago
Offline	UG Gateway 6222A3243835	0 / 1 / 0 Detail	2021-02-03 09:41

- Go to “My Devices” page and click “+New Devices”. Fill in the SN of UC51x and select associated gateway.

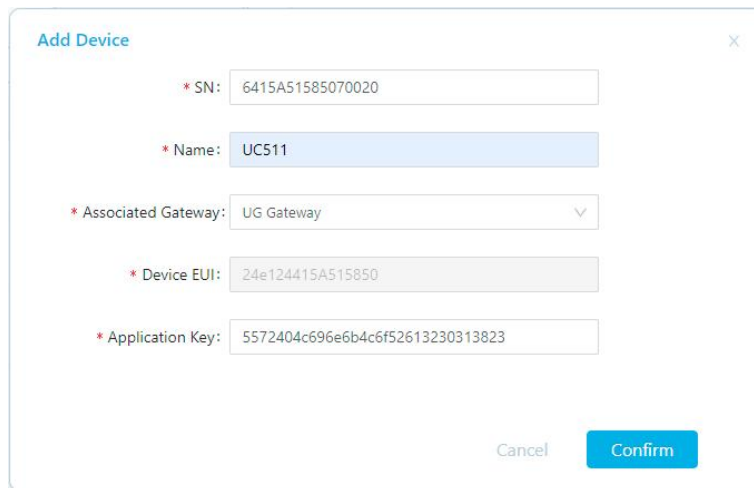

Add Device

* SN: 6415A51585070020

* Name: UC511

* Associated Gateway: UG Gateway

* Device EUI: 24e124415A515850

* Application Key: 5572404c696e6b4c6f52613230313823

Cancel Confirm

3. Click  and go to “Basic Settings” to change class type the same as device settings.

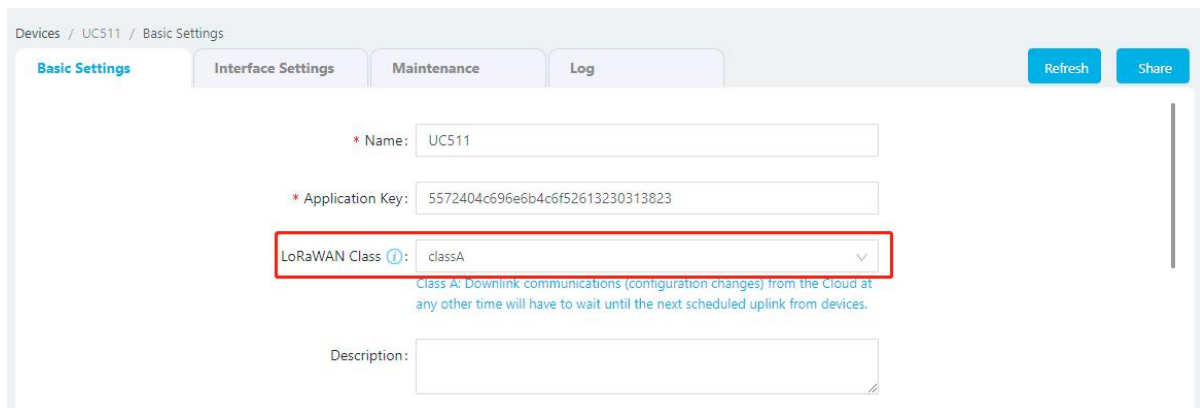

Devices / UC511 / Basic Settings

Basic Settings Interface Settings Maintenance Log Refresh Share

* Name: UC511

* Application Key: 5572404c696e6b4c6f52613230313823

LoRaWAN Class ⓘ: classA

Class A: Downlink communications (configuration changes) from the Cloud at any other time will have to wait until the next scheduled uplink from devices.

Description:

Besides, configure the unit of per pulse if you connect the water meter.

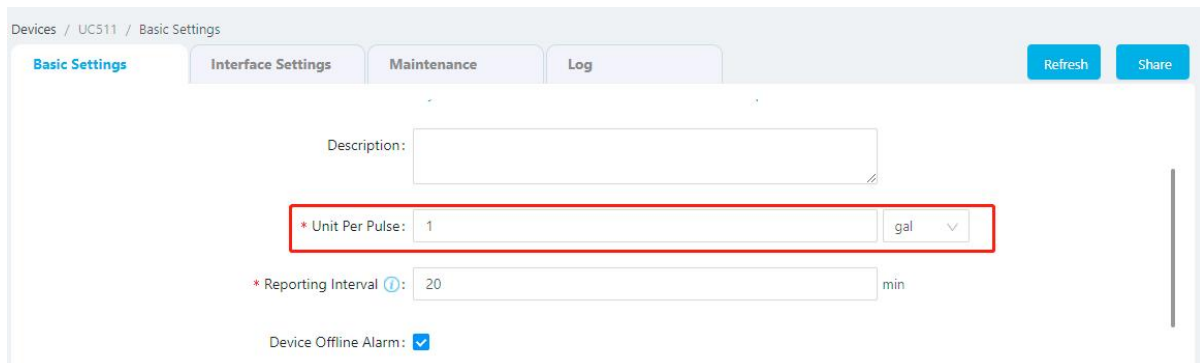

Devices / UC511 / Basic Settings

Basic Settings Interface Settings Maintenance Log Refresh Share

Description:

* Unit Per Pulse: 1 gal

* Reporting Interval ⓘ: 20 min

Device Offline Alarm:

4. Click  and go to “Interface Settings” to select used interfaces and customize the name and thresholds.

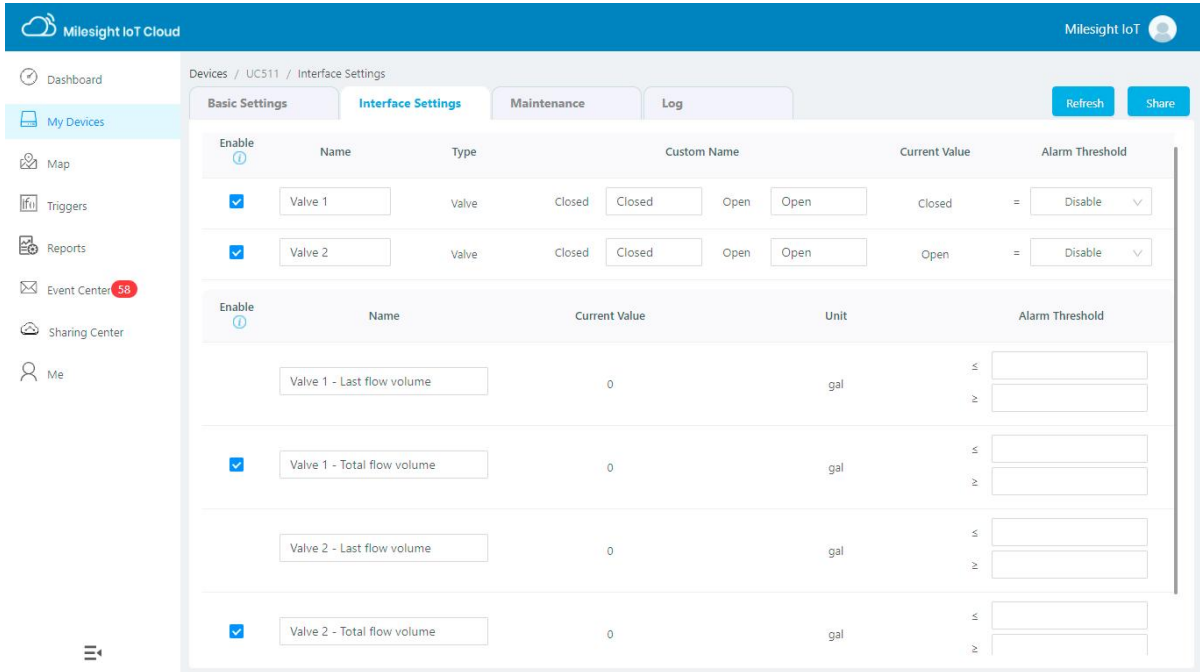

5.2 Solenoid Valve Control

Solenoid valve can be controlled by Milesight IoT cloud webpage or App. **Before control, ensure all schedule plans on device are disabled.**

1. Click  to open the solenoid valve and configure the duration. Note that if you enable any local plan on UC51x device, this control will not work.

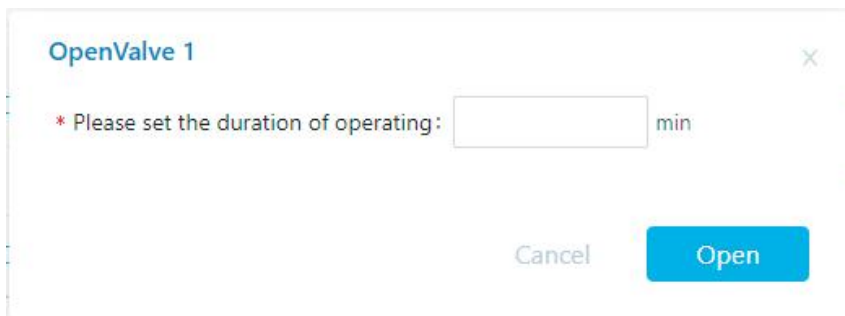
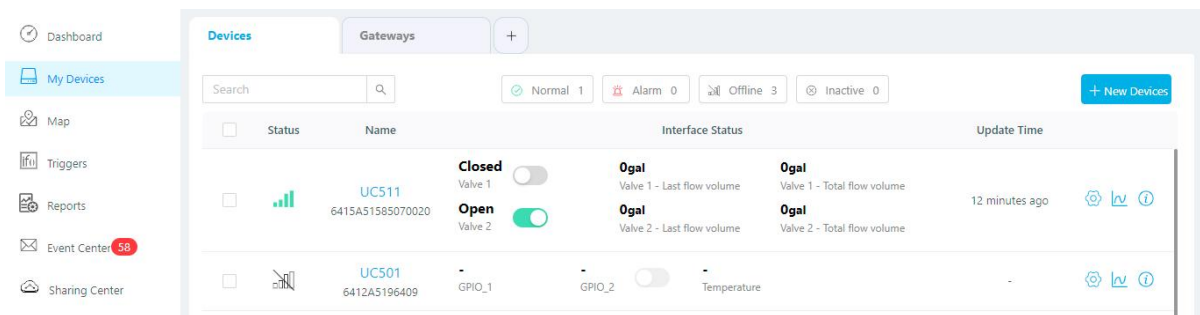

You can also add a switch on the dashboard to control the status of solenoid valves.

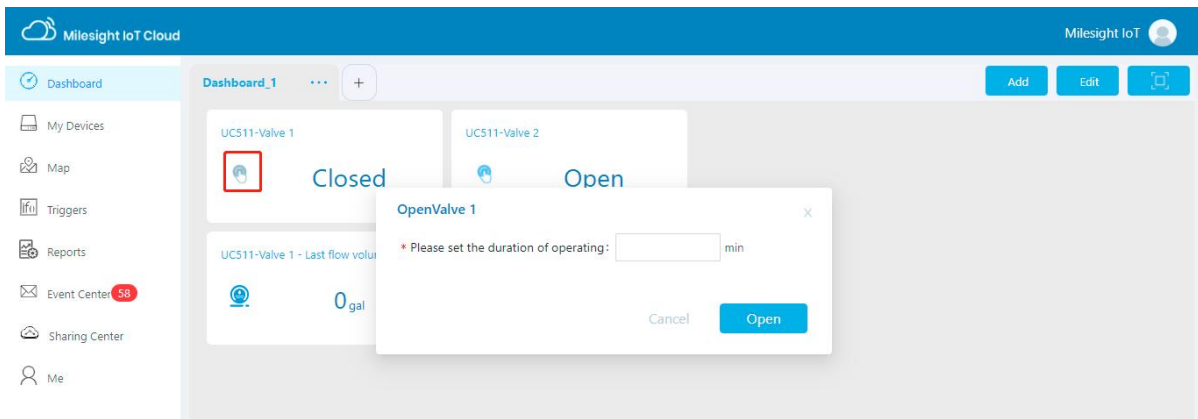

Note: If the working mode of UC51x is LoRaWAN® Class A, control commands will delay until the time icon disappears.

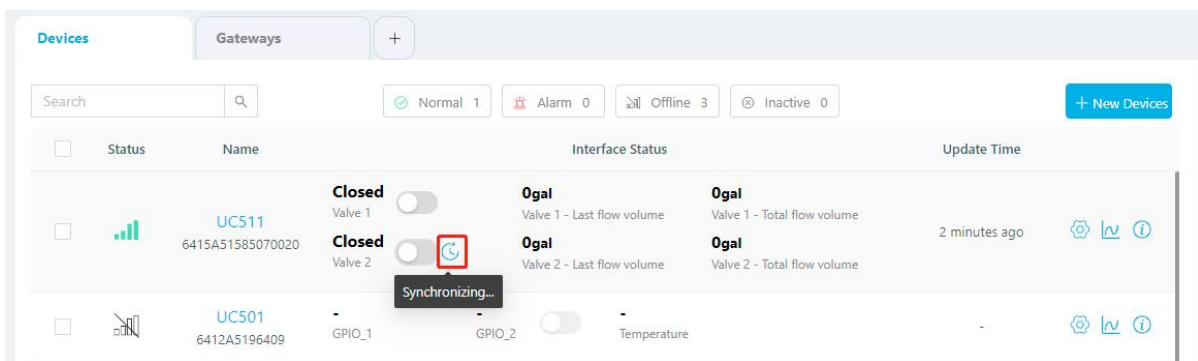

2. Go to "Triggers" page to add actions to trigger the solenoid valve to open for a period of time or a specific volume of water.

Note: Water volume control is only worked when you connect water meter to UC51x device.

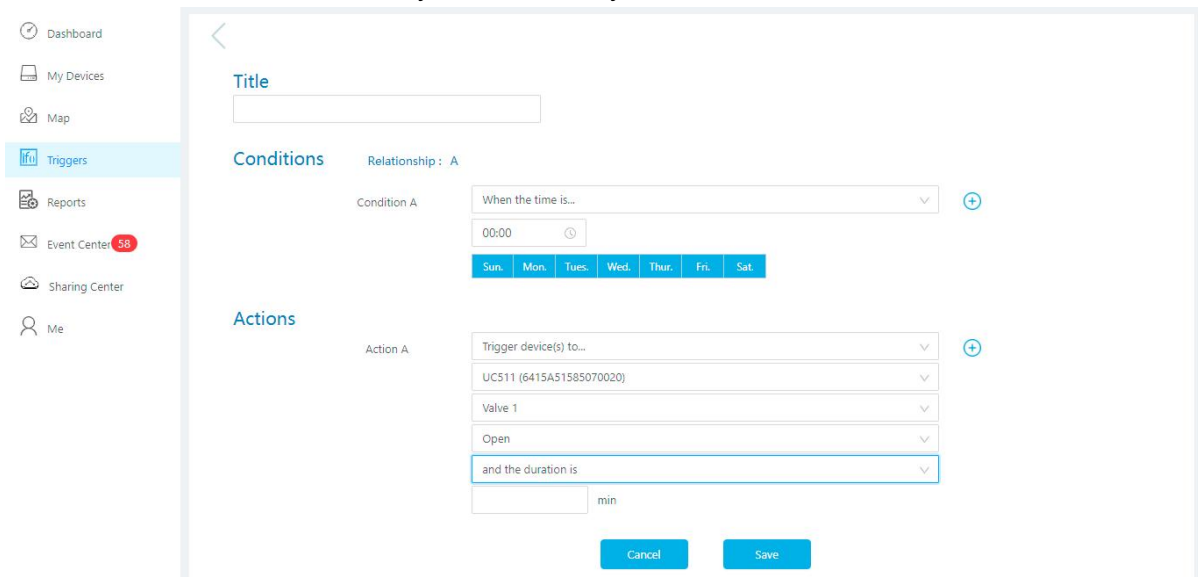

6. Device Payload

UC51x Series use the standard Milesight IoT payload format based on IPSO. Please refer to the *UC51x Series Communication Protocol*, for decoders of Milesight IoT products please click [here](#).

-END-